

# T8 GENESIS WITH PLM INTELLIGENCE

T8.350 | T8.380 | T8.410 | T8.435



**PLM**  
NEW HOLLAND INTELLIGENCE

# Innovation meets intuition.

---

New Holland built the new T8 Genesis™ with PLM Intelligence™ around the input of operators like you. From a reimagined cab designed to offer the most comfortable and convenient driver experience, to next-generation intuitive controls that can be easily customized to the tasks at hand, every detail has been carefully engineered to meet your needs.

The new T8 Genesis™ is also the first tractor on the market to fully integrate New Holland's advanced PLM Intelligence™ platform. So, no matter where you are, you're always connected to real-time insights, information, and support.

All of these advances and innovations have evolved to create the most intuitive tractor the field has ever seen.





### Your partner in the field

Technology will continue to evolve over time, but farming will always depend on a foundation of community and connection. The new T8 Genesis with PLM Intelligence is designed to strengthen and reinforce those bonds, bringing together the people and innovations that make modern agriculture possible.

- **Customer-to-Vehicle Connectivity** - allows you to run your farm business from the cab, the farm office or the other side of the world
- **Dealer-to-Vehicle Connectivity** - helps you maximize uptime with proactive support, remote monitoring diagnostic, and in-field software updates
- **Advisor-to-Vehicle Connectivity** - lets you stay in touch with agronomists and other experts to improve decision-making on the move



## MYPLMCONNECT

### MyPLM®Connect telematics free for 1 year

Assisting fleet managers to optimise machinery management. Providing real time field data at your fingertips. Enabling accurate data management to improve operating efficiency. This all now comes as standard across the entire T8 Genesis™ range, with MyPLM®Connect with file transfer. What's more, in order to improve your uptime, New Holland's Breakdown Assist service has been fully integrated, free of charge.

### T8 Genesis™ wheeled offering



| Models | Rated (hp) | Wheelbase (mm) | Weight (kg) |
|--------|------------|----------------|-------------|
| T8.350 | 280        | 3450           | 11,360      |
| T8.380 | 311        | 3550           | 11,360      |
| T8.410 | 340        | 3550           | 11,440      |
| T8.435 | 380        | 3550           | 13,039      |

### T8 Genesis™ SmartTrax™ offering



| Models | Rated (hp) | Wheelbase (mm) | Weight (kg) |
|--------|------------|----------------|-------------|
| T8.410 | 340        | 3550           | 16,500      |
| T8.435 | 380        | 3550           | 16,500      |

### The right model for your business

Selecting the right T8 Genesis™ tractor for your business is made easier thanks to New Holland offering a choice of power output, transmission type and both wheeled and versatile SmartTrax™ options. Your New Holland dealer can help you choose options to include front linkage and PTO packages, cab and front axle suspension, a choice of work lights, in-cab refinements and, of course, fully integrated IntelliSteer® guidance packages. With New Holland, choice comes as standard.

# Connected for the way you work.

## Customizable control

When the time comes to deliver precision results in the field, there's no room for a "one-size-fits-all" approach. Every operator has their own unique preferences and requirements. So, we built your controls package around the revolutionary idea that custom adjustments should come standard.

## Improved visibility

Whether you're in an open field or on a busy road, awareness of your surroundings is essential. We've reduced in-cab obstructions, placed your InfoView™ dash display in direct line-of-sight and even installed front hood mounted and rear facing cameras for road safety and in-field work. And now with three lighting packages to choose from, you can turn night into day.

## Enhanced comfort

With all the hours you spend in the field, shouldn't work feel a little more like home? We think so. That's why we've added more accessible storage, USB power ports, a powerful Heating, Ventilation and Air Conditioning two zone system, egress lights, and the most comfortable seat outside of your living room.

## Advanced support

When you drive a tractor that measures productivity and precision in seconds and millimeters, you need to maximize uptime in the field. Introducing MyPLM®Connect, stay in touch with your machines at all times, from anywhere. We have incorporated remote connectivity with New Holland Remote Assistance, advanced diagnostics, IntelliView™ Connect remote Display Viewing, and software updates.

## Intuitive simplicity

True innovation doesn't require an advanced degree to operate. To help you harness all of the powerful features and technologies built into the new T8 Genesis™ tractors, we developed a user-friendly interface that feels as natural and instinctive as agriculture itself.

Modern aggressive styling package

Trademark Cat Eye lights

Four standard hood mounted lights

Full integrated front linkage  
with 1000 speed PTO

Terraglide™  
front suspension

FPT Industrial Cursor 9 engine  
featuring ECOBlue™ HI-eSCR 2 Stage V  
technology with up to 435hp  
maximum horsepower



# PLM

NEW HOLLAND INTELLIGENCE



One year MyPLM<sup>®</sup>Connect professional package telematics subscription as standard

Factory installed IntelliSteer<sup>®</sup> guidance system

170° front hood camera and rear cab pillar camera

IntelliTurn<sup>™</sup> end-of-row-turn system is now compatible with Headland Turn Sequencing II function

Up to 24 LED working lights

All new SideWinder<sup>™</sup> Ultra armrest and IntelliView<sup>™</sup> 12 monitor

Advanced seat options

Optional Semi-Active Comfort Ride<sup>™</sup> cab suspension

10 in cab storage spaces

Wide, Full width opening door for easier access and enhanced visibility

Headland Turn Sequencing II (HTS II) system

Tyre Pressure Monitoring System

New fast turning CustomSteer<sup>™</sup> feature

Proven Ultra Command<sup>™</sup> transmission or advanced Auto Command<sup>™</sup> transmission

Tight turning brake assisted steering feature

# Blue Power. Exclusive Edition.

---

The Blue Power range was developed for those agribusinesses which are looking for the ultimate in premium agriculture. Here performance and comfort are of supreme importance. Add to these attributes exclusive styling and you've discovered the most luxurious tractor range ever. Ultimate comfort, cutting edge technology and eye catching design. If you want your tractor to stand out in the field not only for its performance, but also for its looks, then you've found your answer. Available exclusively with an Auto Command™ continuously variable transmission, the Blue Power range is tractor luxury personified.



*Blue*power



**Blue Power. Exclusive edition, exclusive emotion.**

- Distinctive and eye-catching metallic midnight blue paint
- Chrome coloured grille
- Silver wheel rims
- Silver 3D decals
- Blue Power roof insignia
- Available on all T8 Genesis™ Auto Command™ models
- Blue Power branded black thick pile cab carpet

# Experience a revolution in tractor operation.

An ergonomic, spacious and practical operator environment is a must for day-long productivity. That is what New Holland's industry leading T8 Genesis™ cab delivers. Want all round visibility? Whether you're in the yard, in the field or on the road, you'll have an uninterrupted productivity enhancing view. Always. The ultra wide opening door facilitate access for easier entry and exit.



## Enhanced comfort

The T8 Genesis™ range's steering wheel now has separate tilt and telescopic adjustment as standard, which makes it even easier for operators to select a comfortable working position, invaluable when spending long hours in the field or on the road.



## Front and rear sun-visors

The front and rear sun visors have been fully integrated into the cab design, so that when they are not in use you have an uninterrupted view. They can be pulled up and down from the comfort of the seat without stretching.



## Intuitive climate controls

The entire air conditioning system has been redesigned, with a powerful two zone cooling system and precision positioned vents to ensure whole body comfort. All controls have been ergonomically relocated to the SideWinder™ Ultra armrest, making on the go adjustments even easier.



## Stay refreshed on the hottest days

The optional portable coolbox mounted to the right of the operator seat can be easily removed for replenishment







### Good all round vision

The standard enlarged wing mirrors feature an adjustable top section for the best possible view of the road during high-speed transport. The adjustable lower section has been designed to effectively counteract blind spots. Additional options included heated wing mirrors, and entire wing mirror electronic laterally extension to enhance visibility when working with the widest loads.



Thanks to a laminated front windscreen, thicker rubber window and door seals, thicker floor mat and even more insulation under the cab floor, the new T8 Genesis™ cab is even quieter than ever.

## The ultimate in farming comfort.

---

New Holland brings to you the best-in class seat offering, with two different models to choose from. All seats benefit from improved cushioning. These firmer, more durable seat cushions provide outstanding comfort whatever the terrain.



### Plenty of room for all

A standard, full-size upholstered instructor seat folds down to provide a work surface when not in use.



### Auto Comfort™ seat

The ventilated Auto Comfort™ seat offers a premier seating experience. With automatic weight compensation, active suspension, heating and even a ventilation system that cools and removes moisture, this is perfect for operators who spend extended hours in the tractor. The seat is trimmed in blue and grey leather.

### Dynamic Comfort™ seat

The Dynamic Comfort Seat boasts an enhanced low frequency suspension mechanism. The stitched cushions, finished in a stylish cloth, also feature two stage heating.

|                   | Dynamic Comfort™ seat              | Auto Comfort™ seat             | Blue Power Auto Comfort™ seat  |
|-------------------|------------------------------------|--------------------------------|--------------------------------|
| Material          | Cloth                              | Leather                        | Leather                        |
| Suspension type   | Low frequency with dynamic damping | Semi active                    | Semi active                    |
| Damping system    | Automatic                          | 5 modes                        | 5 modes                        |
| Weight adjustment | Automatic                          | Active electronic              | Active electronic              |
| Lumbar support    | Pneumatic                          | Pneumatic                      | Pneumatic                      |
| Climate System    | 2 stage heater                     | Heating and active ventilation | Heating and active ventilation |
| Passenger seat    | Cloth                              | Leather                        | Leather                        |

## Bright lights for dark nights.

---

Lighting up the way for improved night time productivity and total safety is a key New Holland priority, accomplished by bringing into the farming world the latest automotive sector innovations, such as LED lights. The lighting offering features up to 24 LED lights. Brighter and consuming less power than their standard equivalent, these lights offer a broad spread of white light, turning night into day. When the range-topping package is specified, this delivers 49,400 lumens, which is over 30% more light than the previous T8 range. Up to 6 lights can be fitted to the front and up to 8 lights can be fitted to the rear of the roof, while high level headlamps light up the distance and pave the way for non-stop operation.

49,400 lumens over 30% more light than previous T8 range





### Choose a lighting package to suit you

There are three cab LED lighting packages available, consisting of level 1 14 lights (Figure 1), level 2 18 lights (Figure 2) and level 3 24 lights (Figure 3) in various configurations, to suit your individual requirements.



### Fully adjustable lights

The optional 360° package includes an adjustable light at each corner of the cab. Customisable on-off lighting combinations are available, and activated via two lighting memory switches, which can turn on/off banks of lights. Ideal when working alongside a combine harvester, for example.



LED lights are efficiency itself: more light, more durability, less power consumption.

# SideWinder™ Ultra: the ultimate ergonomic farming experience.

The T8 Genesis™ tractors offer sophisticated features that are easy and intuitive to access. The SideWinder™ Ultra armrest hosts all key controls. Throttle, transmission and hydraulics. Everything you need to control is intuitively selected. More advanced features can be quickly accessed.



## Customisable buttons

Up to eleven buttons can be personalized and configured on the SideWinder™ Ultra armrest. Located in strategic positions around the armrest: one on the multifunction handle, two on both the joystick and main keypad, four on the rear keypad and one or two on the throttle/transmission keypad (depending on the transmission option selected). These buttons can be configured to suit both the task in hand and the specific preferences of the operator.



## Adjustable SideWinder™ Ultra armrest

The SideWinder™ Ultra armrest can be adjusted to suit your specific requirements. Two manual levers adjust both the height and fore-aft position of the armrest for enhanced ergonomic operation.

- Front or Rear linkage control selector
- Thumb wheel for position / draft setting
- CommandGrip™ handle
- STOP button to disengage hydraulics, PTO and linkage
- Fingertip control for up to two remote valves
- Front & Rear linkage raise/lower
- Headland Turn Sequencing II (HTS II). Press to record, store and activate automated headland turn
- Forward / Reverse shuttle and neutral buttons
- IntelliSteer® auto-guidance, automated steering engagement
- 1 of 11 configurable buttons
- Fast raise, lower and dig buttons
- Store depth button
- Position or draft selector
- Main tractor functions shortcut buttons
- Terralock™ engagement for automatic management of four-wheel drive and differential lock selection
- Light configuration buttons
- Three stage acceleration and deceleration setting
- 1 of 11 configurable buttons
- Stored Engine Speed Management setting 1 and 2
- Ergonomically positioned hand throttle



**Optional 2 lever hydraulic remote pod**



**Factory installed remote locking and immobilizer**

Multifunction joystick. The joystick can be set to operate the front linkage or remote valves

Tractor speed increase / decrease

Forward / Reverse shuttle switch

2 configurable buttons

Configuration screen shortcut button

Screen back button

Phone, radio and media controls

Climate controls

Intentional PTO switch, which must be selected to keep the PTO engaged when leaving the operator seat

Engage and disengage the front and rear PTO instantly

Auto PTO will disengage and re-engage both the front and rear PTOs during a headland turn

5 Configurable hydraulic valve levers

Thumb wheel encoder

Sliding padded armrest can be moved for increased elbow support when using the joystick or CommandGrip™ handle during transport

Front and rear linkage limits settings

4 of 11 configurable buttons



# Intelligent monitors for intelligent agriculture.

The all new IntelliView™ 12 monitor delivers a whole host of machine benefits at your fingertips. A clear evolution from the former IntelliView™ IV, the new '12' model with its sleek, automotive style 'dash' styling, intuitive display and modern design, will become the benchmark of the future.







### Fully customisable

The standard operational layout sees the screen divided into four main areas:

- The top bar allows the operator to access tractor and operation settings
- The run screens are located on the bottom bar. These are customizable and always accessible
- The main part of the screen is composed of the user selected run screens, which show key parameters related to the task in hand
- The left hand side is another user definable window, which contains primary operating parameters such as fuel rate and slip



### InfoView™ dash display

The large LCD flat screen display positioned directly in front of the steering wheel is your 'at a glance' machine dashboard. Featuring a host of key operating parameters such as engine rpm, forward speed and selected gear, amongst others.



### Perfect view

In order to enhance transport safety, a viewing camera has now been integrated into the hood. When approaching a traffic junction, this enables you to 'see forward' for improved road safety. An additional advantage is that you have a perfect view of front mounted implements, both while working in the field, and when connecting in the yard.



### Dual displays

For those customers who need to run extra monitors the T8 Genesis has dedicated mounting points and associated power and USB ports. Located in the headliner is a sliding rail to accommodate an additional IntelliView™ 12 monitor. For extra convenience, there is a mounting point on the SideWinder™ Ultra armrest for a mobile phone or tablet holder.

## Three factory-fitted guidance packages.

---



When ordering your T8 Genesis™, you can choose between three different guidance packages. This means that your T8 Genesis™ will arrive direct from the factory with the exact accuracy level you require. Choose your accuracy level right down to the most precise 2.5cm\* option. Extremely beneficial for precision arable applications, especially in high value vegetable or bulb farming.

\* Using PLM RTK or PLM RTK+ correction signal



### IntelliTurn™ Intelligent End-of-Row-Turn system

The IntelliView™ 12 monitor can be used to manage the optional IntelliSteer® autoguidance system. The IntelliView™ 12 monitor enables fingertip programming of a variety of guidance paths, from straight A-B runs to the most complex IntelliTurn™ end-of-row turn feature. IntelliTurn improves efficiency by automatically plotting and executing the most efficient turn path to minimize “out of work” time during the turn, as well as ensuring the implement re-enters the infield work area on the desired path. The result is a system that automatically chooses the appropriate turn style (light bulb, constant arc or extended path), plots the most efficient path and executes it. This can now be combined with HTS II (Headland Turn Sequencing II), causing it to be triggered at a preset distance from the headland.

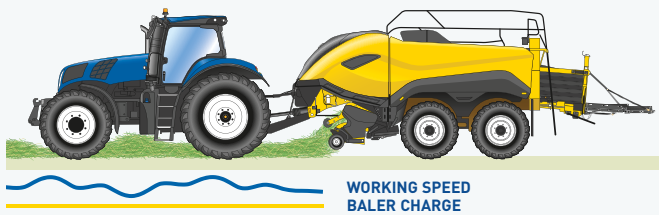

### Two way communication

The T8 Genesis™ range is fitted with ISOBUS II as standard or optional ISOBUS III technology. ISOBUS III means the tractor and implement can communicate with each other, relaying information back and forth, resulting in the implement controlling the speed of the tractor to achieve maximum productivity.

When connected to a New Holland BigBaler this enables the IntelliCruise™ feature, which controls the tractor's forward speed to increase productivity, improve operator comfort, improve fuel savings and optimise feeding rates in varying field and crop conditions. This system has two running modes, Charge Control Mode for maximum capacity or Slice Control Mode to obtain the desired number of slices per bale.



### A choice of three

New Holland offers customers the choice between three differing levels of accuracy

1. PLM 1 = 15cm accuracy
2. PLM 2 = 5cm accuracy
3. PLM RTK & PLM RTK+ = 2.5cm accuracy



### PLM Cygnus Receiver

The new PLM Cygnus Receiver delivers improved machine position thanks to its integrated terrain compensation technology. It also enables quicker convergence times, as well as enhanced reliability in challenging conditions such as when working in valleys and in heavily forested areas.

# My Connected vehicles for efficient farming.

## Connected. Productive. Efficient.

Agriculture is constantly evolving, and split second decisions have an enormous impact on your business' profitability. New Holland's goal was to place farm managers and contractors in every field, even when they are sometimes hundreds of miles away. This is now possible thanks to MyPLM®Connect. Using mobile telephone technology, users receive dynamic, real-time information on every machine working in their field and can analyse that data to make correct decisions for each and every machine in each and every field.

## MYPLM®CONNECT

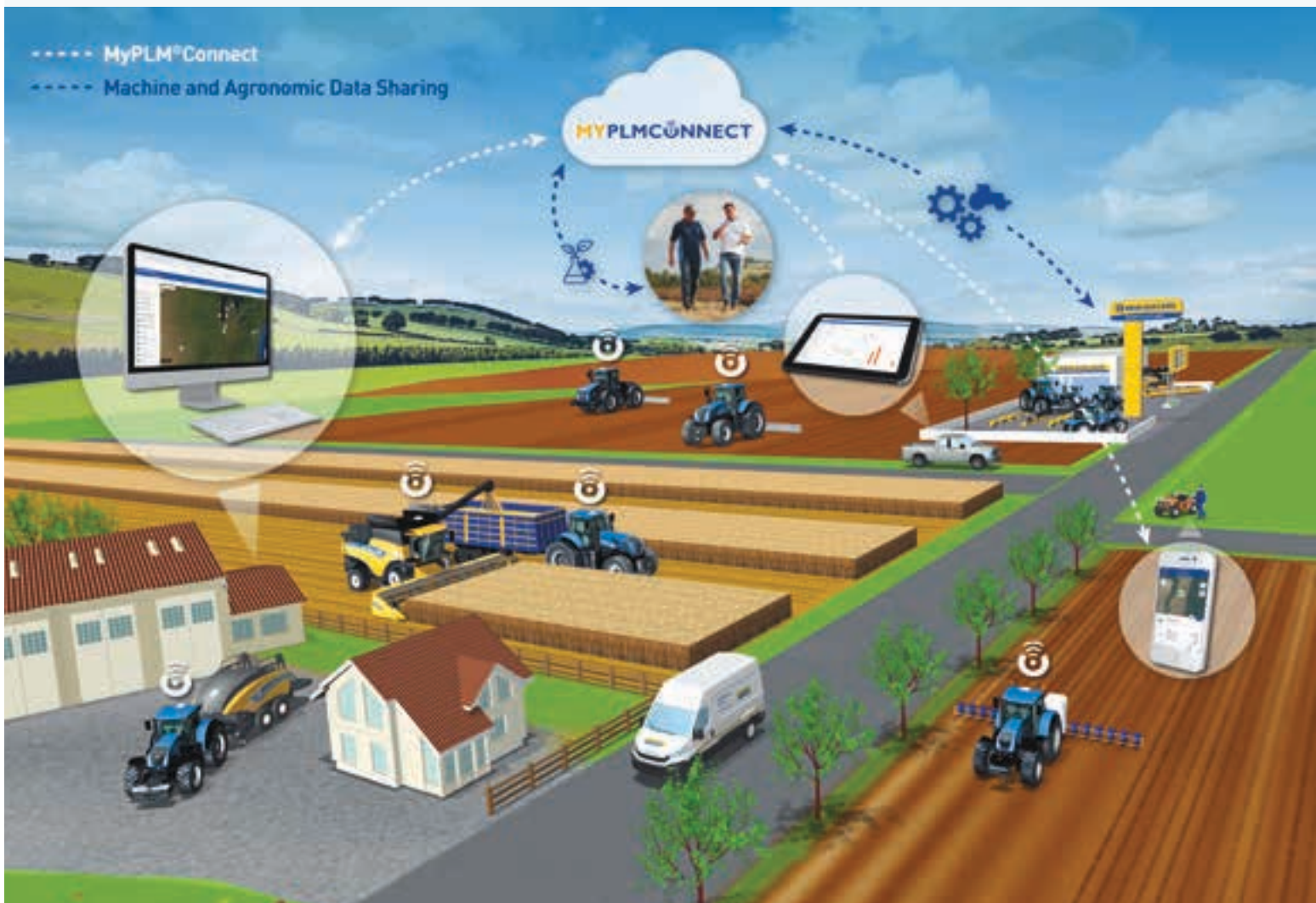

### Telematics: manage your machine from the comfort of your office

MyPLM®Connect enables you to connect to your T8 Genesis™ from the comfort of your office through the utilization of the mobile network. You can stay in touch with your machines at all times, and you can even send and receive real-time information that saves time and enhances productivity. The entry-level MyPLM®Connect Essential package offers the most frequently used features or upgrade to the MyPLM®Connect Professional package for full machine monitoring and control. In short, MyPLM®Connect will help you to reduce your fuel bills and improve fleet management and security in one simple package.



### **MyPLM®Connect Professional package free for 1 year on T7 and T8 Genesis™ ranges**

Assisting fleet managers to make right time decision. Providing real time field data at your fingertips. Enabling accurate data management to improve operating efficiency. This all now comes as standard across the entire T7 and T8 Genesis™ ranges, with MyPLM®Connect. What's more, in order to improve your uptime, New Holland's Breakdown Assist service has been fully integrated, free of charge.

### **Access to MyPLM®Connect Portal through MyNew Holland™**

MyNew Holland™ provides owners and users the ability to view and manage their machinery fleets online. Users will be able to access a range of information such as operator manuals and how-to videos as well as an option to view activations and subscriptions via the live link to the VMS tool. Users can even make purchase requests direct with their dealer to activate a service or takeout a subscription. MyNew Holland™ also provides direct access to the MyPLM®Connect Portal.

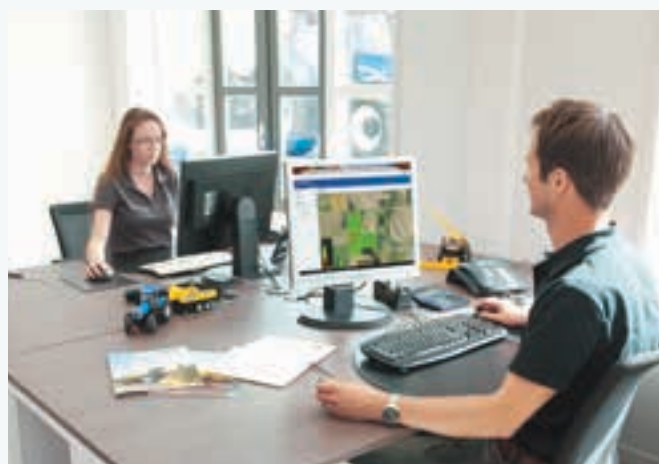

### **PLM® Certified Dealers**

In order to deliver top quality service and support, New Holland has developed the PLM® Certified Dealer programme. Wherever you see this logo, you're sure to find experts to support your PLM® investments.



# The power and efficiency you've come to expect from New Holland.

The 8.7 litre FPT Industrial Cursor 9 engines, featuring ECOBlue™ HI-eSCR 2 technology, continue to set the standard for engine performance, dependability and efficiency yet still meet the latest Stage V emission regulations. When it comes to fuel efficiency, T8 Genesis™ series tractors are seldom bettered. This is paired with long, 600 hour main service intervals.



*Sustainable Efficient Technology*

**ECOBlue**

**HI-eSCR2**



## ECOBlue™ HI-eSCR 2 explained

The entire T8 Genesis™ range complies with Stage V emissions standards, which mandate a further 40% reduction of Particulate Matter content compared to previous Tier 4B / Stage 4 regulation. This is achieved thanks to the new HI-eSCR 2 technology developed by FPT Industrial. This innovative after treatment system is a maintenance-free, patented solution that minimizes operating costs.



### Powered by FPT Industrial

New Holland is not going it alone when it comes to Stage V technology. They can draw on the experience of their in-house engine development group: FPT Industrial.

**Pioneers:** Fiat invented Common Rail technology in the 1980s and brought it to the masses in 1997 on the Alfa Romeo 156. They were the very first to introduce it on agricultural machines on the TS-A tractor. Pioneering. Always.

**Cleaner:** For the ninth consecutive year, CNH Industrial has topped the Dow Jones Sustainability World and Europe indexes for the Industrial Engineering sector. Cleaner Everywhere.

**Proven:** FPT Industrial has pioneered SCR technology since 1995 and has already produced over 1 million SCR engines during the last eight years for the agricultural, construction and haulage industries. Reliability. Confirmed.

### Engine Power Management explained

With EPM, the engine develops more power and torque according to the load on the transmission, hydraulics and PTO. On a T8.350 tractor, EPM will deliver up to 71 horsepower extra, but only when it is needed, to maintain performance.

- Rated hp: power produced at rated engine speed
- Max. hp: power the engine can develop, in the working range
- Rated EPM hp: maximum power the engine can develop using EPM when conditions allow, at rated speed
- Max. EPM hp: maximum power the engine can develop using EPM when conditions allow, in the working range

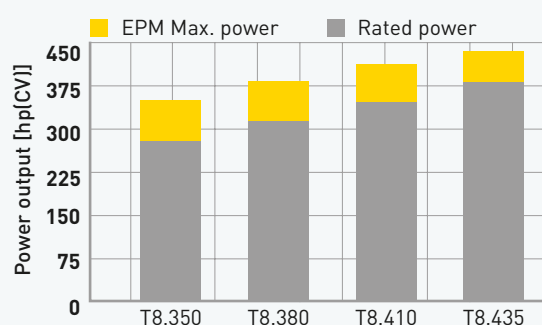

### All the power you need always available

Here at New Holland we're passionate about transient response. You might think so what. But it's your productivity guarantee. Put simply, as your Cursor 9 engine only breathes clean fresh air it can react even quicker when placed under load. Significantly quicker in fact. Transient response. We've got it covered.

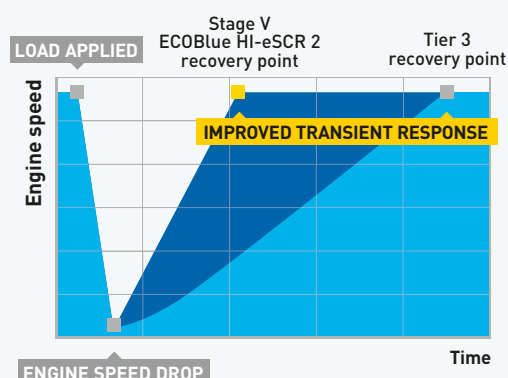

# Full Powershift Ultra Command™ for rugged efficiency.

---

Ultra Command™ full Powershift transmissions match proven mechanical efficiency to New Holland ease of control. The result? A transmission that is easy to set up and operate with a speed to perfectly match every application. In short, it's the most efficient full Powershift available today. Available on the T8.350 - T8.410 models, the CommandGrip™ handle provides fingertip access to automated features, that include Ground Speed Management. Choose between 18x4 and 19x4 (40kph ECO or 50kph) direct drive. Ease of use comes as standard.





## GSM. Intelligent automation.

New Holland Ground Speed Management, GSM, is more than just an automated transmission shift system. With CVT-like functionality, it uses a combination of data relating to engine load, forward speed and operator setting, to manage both engine and transmission speeds to optimise performance and economy. Simple to set up and extremely efficient, GSM is well proven and dependable.

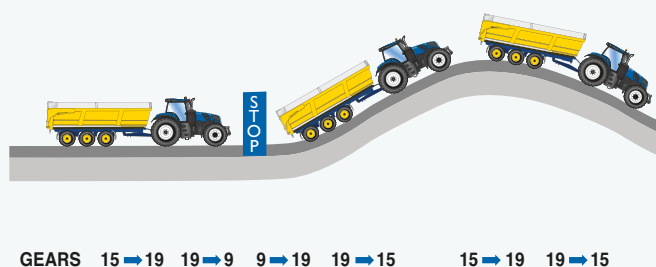
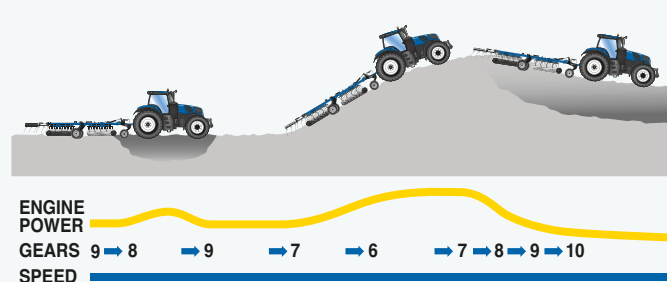

### Fixed forward speed? GSM takes care of it.

When load conditions change in the field, GSM will automatically maintain a fixed forward speed. The operator first sets the desired working speed and then selects the GSM function. The automated system will then match engine and transmission speeds to maintain this fixed forward speed, to deliver the perfect balance between maintaining productivity without compromising economy.

### Full command in transport

During road transport, GSM will automatically shift the transmission according to load and throttle settings. Starting from your pull-away gear, GSM will auto shift the ratio all the way to your top speed.



### IntelliView™ - gear and speed at a glance

The standard IntelliView™ 12 monitor is configurable to provide a dedicated information panel to the left side of the screen, giving a clear read out of the selected transmission ratio and tractor speed.



### Ultra Command Powershuttle

The forward reverse shuttle is operated via the steering column or the CommandGrip™ handle fitted on the SideWinder™ Ultra armrest. It can be programmed to automatically manage transmission shifts during a direction change to match or alter forward and reverse speeds. For ultra safe parking, the park lock is easily engaged using the shuttle lever.

# Innovative Auto Command™ transmission offers advanced New Holland features.

Designed and built by New Holland over 25,000 multi award-winning Auto Command™ continuously variable transmissions (CVT) have been built. The Auto Command™ transmission benefits from four direct drive points with 100% mechanical efficiency. These points have been precision engineered to ensure that they perfectly match the most frequently used speeds during heavy draft work, secondary cultivation activities, high speed in-field work, such as baling or mowing, and high speed transport activities. Advanced double clutch control further enhances efficiency. Quite simply, it is the smoothest and most productive CVT around.

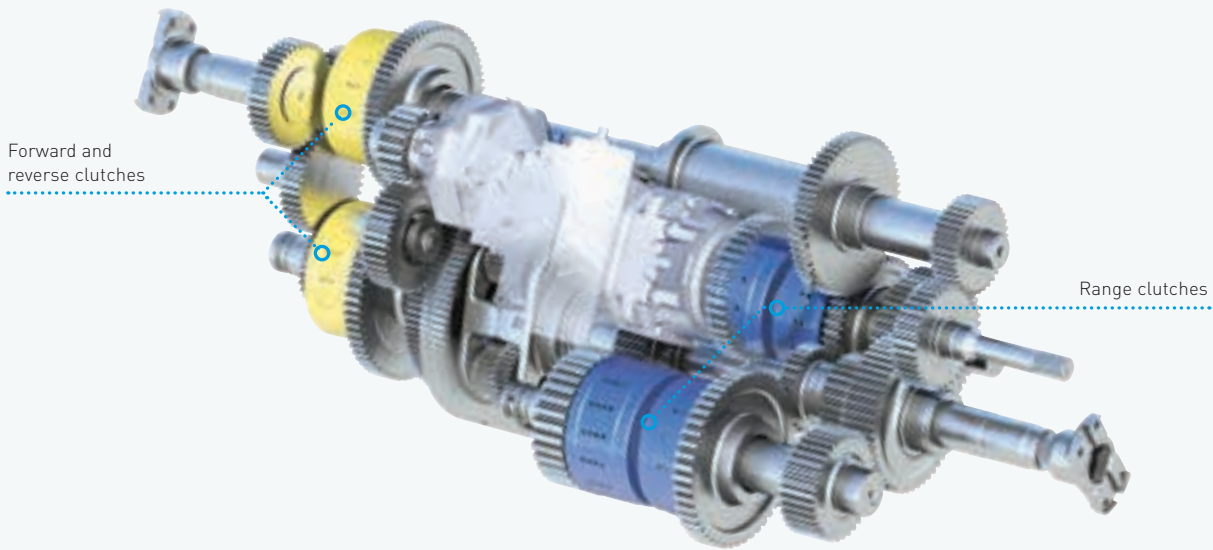

Force based movement enables the operator to change speed and direction. Forward speed can also be controlled using the foot pedal.

Target speed adjustment – set a target speed to match your exact needs.

Target speed selection – allows you to change between three target speeds.

4 driving modes to suit your driving style

**Auto Mode.** Once the desired target speed is achieved, Auto Command™ will match the engine and transmission to maintain it.

**Cruise Mode.** Cruise Mode allows the operator to achieve a set target speed at the touch of a button, and to maintain the speed for economy and productivity.

**Manual Mode.** Allows the operator to manually set the required engine and forward speed, independently of each other.

**PTO mode.** As soon as the PTO is engaged, Auto Command™ will operate to achieve a constant engine speed.



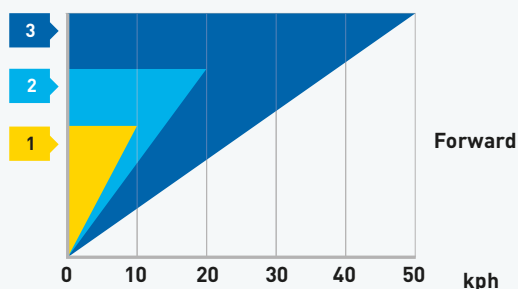

### Three adjustable target speeds for every need

Auto Command technology allows the operator to set a target speed of between 20m/hr right through to 50km/hr and regulate it to the nearest 0.01kph. No steps. No range changes. Just seamless speed to match your every need.



### Tailored transmission settings

The multi-award winning Auto Command™ continuously variable transmission now features a three-stage acceleration and deceleration setting. The 'soft' setting is suitable for gentle direction changes, perfect during high speed transport or when working on slippery surfaces. The standard setting has been designed for normal field activities. The super-fast aggressive setting is ideal when near instantaneous direction changes are required.



### Active stop start

A key safety feature of Auto Command™ is Active StopStart. When the tractor is brought to a standstill, the transmission prevents the tractor moving backwards or forwards, even with a heavy load. When the transmission takes up drive there is no risk of roll back on steep inclines. For safe parking, an electronic brake is easily engaged via the shuttle lever.



### Balancing fuel economy and productivity

When working in Auto and Cruise modes, use the droop control setting, which can be adjusted in the transmission setup screen of the IntelliView™ 12 display or by accessing this setup screen via the quick key button on the SideWinder™ Ultra armrest, to limit the upper engine speed used to achieve the desired forward speed. The result: you reach target speed at much lower engine revs, saving you fuel. In PTO mode, use droop control to regulate the acceptable reduction in PTO speed before forward speed is reduced.

## Traction without question.

The new T8 Genesis™ range has the longest wheelbase in the segment. Ultra Command models boast a 3450mm wheelbase, and 3550mm on the T8.435. That is a full 250mm longer than the nearest competitor. A longer wheelbase means greater stability at high transport speeds, is easier to ballast with better weight transfer, and more traction for demanding heavy drawbar applications.



T8 WHEELBASE

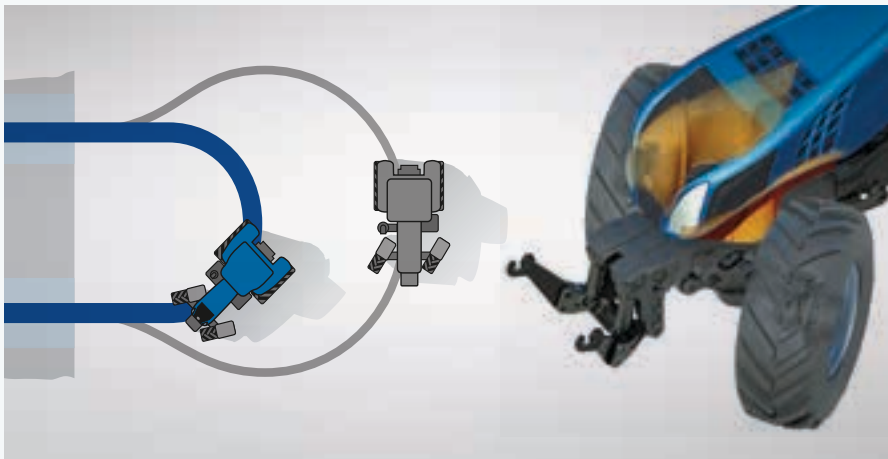

### **New Holland T8 Genesis™.** **A wheeled advantage over competing conventional tractors.**

**Reduced turning circle.** Mounted far forward, the front axle is matched to a tapered engine hood. This allows the hubs to turn to a full lock of 55 degrees, even when large front tyres or dual wheels are fitted.

**Class leading manoeuvrability.** With a turn radius of just 4970mm, a wheeled T8 Genesis™ tractor can turn tighter and return to work faster.



COMPETITION WHEELBASE



### Heavy duty axles for heavy duty performance

The heavy duty axle is fitted to the T8.435 as standard. The 127mm bar axle is designed to cope with the massive power and torque developed from the Cursor 9 engine and transmit it into tractive force. It can also accommodate the largest 2.15m tyres, such as the 900/60R42 option.

## More stable transport. Smoother in-field performance.

---

The T8 Genesis™ range features up-rated front axles in line with its 20 tonne gross vehicle weight, which mean that you can work with even heavier attachments with ease. Terraglide™ front axle suspension is a standard feature and its twin dampers and accumulators deliver a silky smooth ride. The engine and subframe have been designed to maximize turning performance, so that the front wheels can nip in tight against the sculpted sump and tombstone for tight turning.



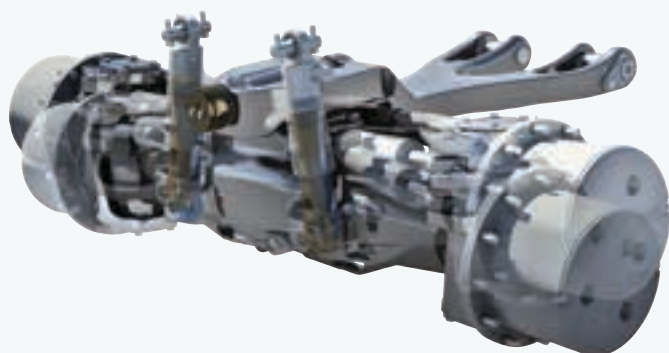

### **Terraglide™ front axle suspension**

New Holland Terraglide™ front axle suspension is proven to protect the tractor, mounted implements and the operator from heavy shock loads during transport and in the field. In the field the advanced suspension system maintains contact between the tyre and the ground to improve traction. Full suspension travel is always maintained thanks to the system adapting to changes in the weight applied to the front of the tractor.



### **All-new Semi-Active Comfort Ride™ cab suspension**

The optional Semi-Active cab suspension system uses a network of sensors which monitor cab position, velocity and acceleration, together with cab pitch and roll to automatically adjust the individually controlled hydro-pneumatic rear cab suspension struts to ensure the smoothest ride. The operator can select from three different modes normal, soft - used to absorb large bumps, ideal when working in soft and rough terrain at slow speeds or hard - ideal when working at higher speeds and during road transport.



### **Advanced traction management**

The New Holland Terralock™ system enables the operator to simply select the traction package needed for a specific application. Terralock will then manage drive to the front axle and engage and release the differential locks automatically. During a headland turn or moving from work to transport, Terralock will unlock the differentials and four wheel drive without operator intervention.

# SmartTrax. The half-track advantage.

---

SmartTrax T8 Genesis™ models represent a key advance in conventional tractor design, combining the in field advantages of a wheeled tractor with the flotation and traction benefits of a tracked machine. Factory developed specifically for the T8 Genesis™ series and available on T8.410 and T8.435 models, SmartTrax are not simply a 'bolt-on' alternative to rear wheels. Detailed modifications to the transmission and driveline ensure maximum power and torque can be transmitted to the tracks for dependable performance in the most demanding of applications.

## Comfort as standard

Solid tracks cannot deliver the same cushioning from shock loads as a tyre. With T8 Genesis™ SmartTrax, the optional specially tuned suspended front axle and standard cab suspension help to cushion the ride for a genuine comfort advantage over a twin-track machine.





### Contour following

Over uneven terrain, the pivoting SmartTrax undercarriage can articulate to follow the ground. Result? Continuous soil contact and the ability to work in diverse conditions and terrain for true New Holland versatility.

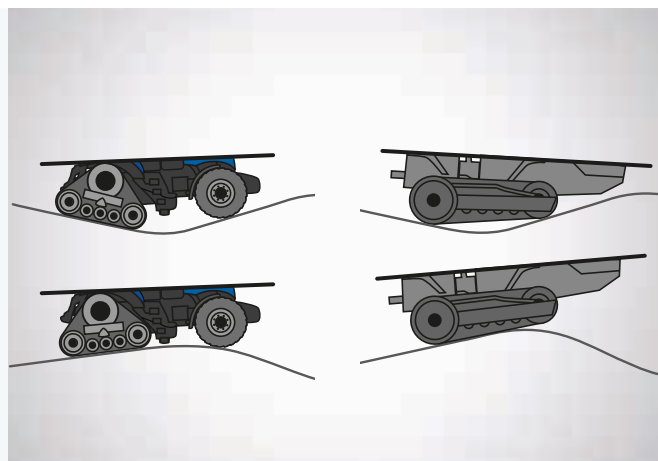

### Terralock™ advantage

The combination of driven front wheels and SmartTrax deliver outstanding traction. Powered front wheels deliver the agility of a conventional tractor while the Terralock™ differential lock management system ensures the tractor stays on line in work, without snaking in greasy patches, unlike twin-track machines. In high draft applications, a T8 Genesis™ SmartTrax delivers the optimum balance between power and performance.



### Get on, stay on

Get going sooner, keep working longer. A lighter footprint has obvious advantages in helping to reduce compaction. But it delivers more. With SmartTrax you can start working earlier and stay working later in conditions that could compromise a twin-track tractor. Productivity and soil care can go hand in hand.

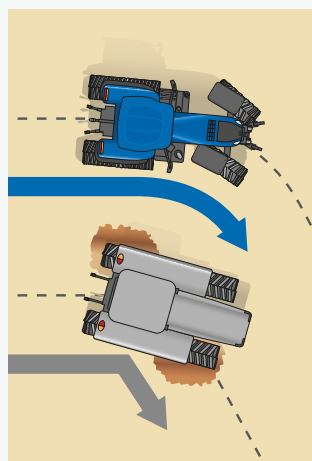

### Turn without the berm

During a tight headland turn, a tracklayer can cause damage to the soil, creating a "berm" ridge. With SmartTrax, tight turns are cleaner and less damaging. The result: no more rough headlands.

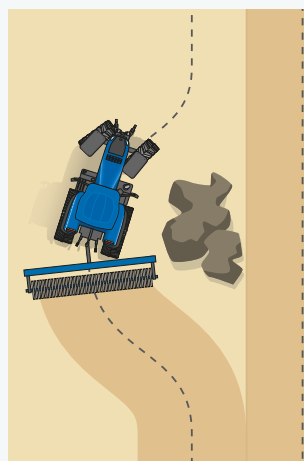

### Full power turns

When working on headlands or around obstacles, where an element of turning is required with the implement still in the ground, SmartTrax has the advantage of allowing full power to be maintained throughout the turn. With SmartTrax, forward motion is not compromised by steering.

# On the right track.

New Holland's SmartTrax™ rubber track technology is the fruit of many years of intensive research and development in collaboration with farmers the world over. SmartTrax™ feature some of the most advanced technology to ensure they deliver in your fields. Day in. Day out. All year round.



Ductile cast iron drive wheel

Clear bearing caps to view oil level

Automatic hydraulic track tensioning system

3 bolt on idler bogies with rubber suspension mounts

7-8 lug positive engagement with drive wheel

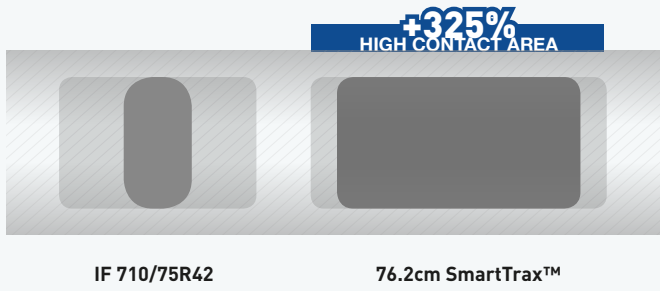

**High flotation**

The ground contact area of a SmartTrax track will be up to 325% greater than a tyre. A bigger and longer footprint delivers better traction in sandy or tilled soil conditions.

| SmartTrax track size      | 45.7cm | 61cm | 76.2cm |
|---------------------------|--------|------|--------|
| 193cm spacing (Factory)   | ●      | ●    | –      |
| 203.2cm spacing (Factory) | ●      | ●    | –      |
| 223.5cm spacing (Factory) | ●      | ●    | ●      |
| 304.8cm spacing (Factory) | ●      | ●    | ●*     |
| 345.4cm spacing (DIA)     | ●      | ●    | ●      |
| 365.8cm spacing (DIA)     | ●      | ●    | ●      |
| 386.1cm spacing (DIA)     | ●      | ●    | ●      |

● Available – Not available \* Not available from factory, but are available as a Dealer Installed Accessory (DIA)

**Track width**

SmartTrax can be fitted with tracks of 45.7, 61 and 76.2cm width. From row crop to broad acre farming, there is a SmartTrax option to fit your specific needs.



**Track spacing**

New Holland provides a variety of track options not only for rowcrop applications with track settings from 193cm.

# Super safe, super stable transport.

For today's modern farmers and contractors, high speed transport is a fundamental part of daily life. Whether you are travelling between clients or between far flung fields, you will appreciate the T8 Genesis™ impressive road handling. Outstanding visibility, precision Auto Command™ speed control and a range of braking options, make the T8 Genesis™ a true road cruiser.

## Brake assist for tighter turning

In order to deliver enhanced turning performance, the brake assist feature has been developed for the T8 Genesis™ range. As soon as the turn is initiated, a controlled braking force is applied to the rear inside wheel to assist in delivering tighter turns.

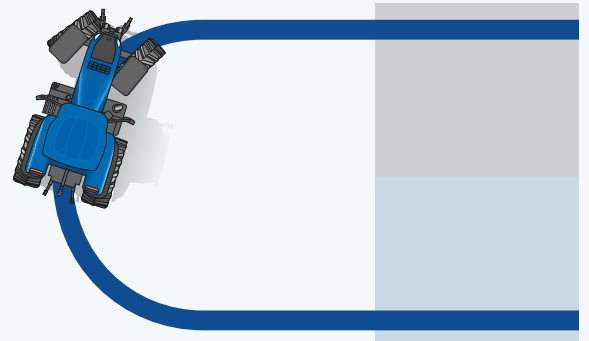



### CustomSteer™ variable ratio steering

The optional CustomSteer™ function puts you in control of steering wheel inputs. Through the IntelliView™ 12 monitor or via a dedicated switch, you can control just how many turns of the wheel are required for lock-to-lock functionality. If you want to conduct tight turns, say when turning on the headland, you can programme the tractor to deliver lock-to-lock turning with anything as few as one complete steering wheel revolution, instead of the standard four. Saving you time and effort.



### Safe Braking technology

The T8 Genesis™ can be specified with an engine exhaust brake, which is activated by a foot pedal, or the Auto Command transmission ratio can be manually locked whilst braking. Pushing the shuttle button on the CommandGrip™ multifunction handle in the direction of travel will lock the transmission ratio. This provides increased engine braking but also allows the tractor and trailer to slow at the same rate, avoiding the risk of a jack-knife situation on slippery surfaces.



### Tyre pressure monitoring system

Operators can check the pressure of up to 16 tyres with the tyre pressure monitoring system (TPMS). Sensors on each tyre transmit via wireless to an antenna within the cab roof. For each tyre the operator can input the ideal working pressure for a specific task. The pressure values are saved against the implement name within the IntelliView™ 12 monitor, so you only need store settings once. An on screen warning then alerts the operator if the pressures are not in line with the ideal value. The TPMS benefits operational efficiency, warning if the pressures are set incorrectly, and provides an early warning of any potential punctures on a trailer for example.

## Ready for modern demands.

The T8 Genesis™ range features impressive front and rear linkage capacity, which means it can work with the very largest front and rear mounted equipment to enhance your productivity. Want to use the largest ploughs? Then the beefy rear linkage is perfect. If you're a potato farmer or you need to mount the very heaviest seed hoppers, then the fully-integrated front linkage is for you. Available in both category III and IV variants, and with a variety of drawbar options and sliding hitches, your tractor can be specified to suit your specific requirements.



### Strong, efficient and powerful

The maximum lift capacity on T8 Genesis™ tractors is a massive 10,927kg. The system also incorporates integral dynamic ride control shock load protection. This will reduce bounce when travelling with a heavy linkage load at transport speeds. Fender mounted controls for the rear linkage, a rear remote and the PTO are available.



### Factory Fitted Front Linkage and PTO

The slim engine hood provides excellent forward visibility. The balanced wheelbase makes it even easier to make full use of the linkage's 5810kg lift capacity. Integrated electronic front linkage controls are within easy reach of the operator.



### Flexible ballasting

Thanks to the optional modular weight block and fully integrated front linkage, ballasting is now even easier. You can choose between a whole host of front ballasting options to perfectly suit each individual application. They can be quickly fitted and simply removed thanks to the dedicated pallet fork slots.

## Features to boost your productivity.

---

New Holland T8 Genesis™ tractors are designed to offer exceptional heavy draft performance. This is a key demand of tractors developing in excess of 400hp(CV). But T8 Genesis™ tractors are built to do a lot more. PTO and hydraulic performance is maintained, even in demanding conditions, thanks to the constant power curve. Massive performance with optimum economy. The T8 Genesis™ reaches rated PTO speed at reduced engine speed for maximum fuel efficiency. With New Holland T8 Genesis™ versatility comes as standard.



### Direct drive for fuel efficiency

All T8 Genesis™ tractors are fitted with a direct drive PTO to minimise power loss between the engine and the implement. The PTO is engaged via a forward sliding switch, with advanced Soft Start management. This modulates engagement of high inertia attachments to protect the driveline and provide smooth engagement of implements. Safety has been further enhanced with the inclusion of an intentional PTO switch, which must be selected to keep the PTO engaged when leaving the operators seat. Additional PTO options include Auto PTO which can be selected to automatically disengage the PTO as the front or rear linkage is raised above a pre-set position. This protects the PTO shaft and tractor.







### PTO

A front mounted 1000rpm PTO is available, whilst at the rear, either a 540/1000rpm shaft or a heavy duty 20 spline 1000rpm shaft is offered. PTO management is integrated into the Headland Turn Sequencing II system.



### Headland Turn Sequencing II and IntelliTurn™ system: hassle free repeatability

HTS II is available on T8 Genesis™ models. This intuitive system means you can easily record and store all implement sequences and operations at the headland. These can then be played back at the touch of a button. Now, it gets interesting. It's even easier to modify pre-recorded sequences, so when things change, your HTS sequence does as well! If you want the ultimate in turning simplicity, combine this with IntelliTurn, the automated end of row turning functionality, which triggers HTS II when it reaches a preset distance from the headland, two great ways to improve repeatability and efficiency as well as to reduce fatigue when working over extended periods.

# Hydraulic Power.

---

All T8 Genesis™ tractors are fitted with an advanced Closed Centre Load Sensing hydraulic system as standard. Delivering 157 litres/minute as standard, or when specified with the high flow option 214 litres/minute, which is enough to power the majority of farming applications. For the most hydraulically demanding customers, the MegaFlow™ option offers an impressive 271 litres/minute of flow. If that wasn't enough, New Holland has engineered the CCLS system to operate at peak efficiency. The benefit? Full hydraulic power is always available at the remote valves and linkage, but only as much as is needed. The result? Reduced fuel consumption.





### Hydraulic remote valve management

It is now even easier to control hydraulic functions, as each hydraulic remote valve is indicated by a coloured LED paddle. The remote paddle position on the SideWinder™ Ultra armrest is completely configurable, so operators can choose which paddle operates which hydraulic remote. This makes it easier to customize usage based on application and operator preference.



### Quick and simple flow control setting

The IntelliView™ 12 touchscreen monitor makes setting flow rates to individual valves simple. Scroll through the menus and select valve control. Choose the outlet you wish to adjust, and drag the slider with your finger to the desired setting or use the front armrest encoder wheel. Job done.



### Up to 9 configurable electronic remotes

T8 Genesis™ remote valves are easy to identify with color-coded couplers and levers. All nine remotes can be controlled from the SideWinder™ Ultra armrest, allowing you to identify and work each remote with exact precision. Five remote levers are on the armrest and two valves are controlled either using the two additional paddles located to the right of the IntelliView™ 12 monitor, or by using the CommandGrip™ handle or by using the electronic joystick which can now control up to 6 remotes. Flow, timing and detent settings can be set to precisely match the job.

# 360°: T8 Genesis™ tractors.

The T8 Genesis™ range has been designed to spend more time working and less time in the yard. All service points are easy to access, and super long service intervals mean they will spend more time in their natural environment: the field!



Single piece engine hood opens wide for full service access.

A built in step makes reaching the front screen for cleaning safe and secure.

Top up the screen wash bottle through the rear window.

The engine air filter is easy to check, clean or replace, with no need for tools from ground level.

Cooling package opens out to make cleaning faster and easier.

A handy built in tool box has been integrated into the front weight.

Engine and hydraulic oil check and fill points are easy to reach making routine checks fast and servicing simpler.

The fill point for the 99 litre AdBlue additive tank is located beside the main diesel fill point for convenience, and it only requires top up when filling the fuel tank. Both diesel and AdBlue tank are lockable for added security.

Cab air filter can be easily changed.



## Dealer Installed Accessories

A comprehensive range of approved accessories to optimise machine performance in all conditions can be supplied and fitted by your dealer.

# New Holland Services.



## Finance tailored to your business

CNH Industrial Capital, the financial services company which serves New Holland, is well established and respected within the agricultural sector. Advice and finance packages tailored to your specific needs are available. With CNH Industrial Capital, you have the peace of mind that comes from dealing with a financing company that specialises in agriculture.



## Trained to give you the best support

Your dedicated New Holland dealer technicians receive regular training updates. These are carried out both through on-line courses as well as intensive classroom sessions. This advanced approach ensures your dealer will always have the skills needed to look after the latest and most advanced New Holland products.



## Service Plus – because your peace of mind is priceless

Service Plus programme provides owners of New Holland agricultural machinery with repair services covering your machinery over the Manufacturer's contractual Warranty. Maximum control over operating costs, repairs completed by authorized NH Dealers using NH genuine parts, higher re-sale value of your machine, transferable coverage. You can choose from three levels of coverage:



**Silver Cover - Powertrain**

**Gold Cover - Extended**

**Platinum Cover - Full Repair**

- The number of years of the cover: two, three, four or five years
- The number of hours of use (or number of bales for balers)
- Many other options to tailor the programme and meet your expectations

Please refer to your Dealer about how to take out a Service Plus contract for your machinery



## New Holland App

iBrochure - NH Weather - NH News - Farm Genius PLM Calculator  
- PLM Academy



## New Holland Style

Want to make New Holland a part of your everyday life? Browse the comprehensive selection on [www.newhollandstyle.com](http://www.newhollandstyle.com). A whole range of items are available including hard wearing work clothing and a vast selection of scale models, together with so much more. New Holland. As individual as you.

| Models  | T8.350              | T8.380              | T8.410              | T8.435              |
|---|---------------------|---------------------|---------------------|---------------------|
| <b>Engine*</b>  | <b>FPT Cursor 9</b> | <b>FPT Cursor 9</b> | <b>FPT Cursor 9</b> | <b>FPT Cursor 9</b> |
| No. of cylinders / Aspiration / Valves                              | 6 / eVGT / 4        | 6 / eVGT / 4        | 6 / eVGT / 4        | 6 / eVGT / 4        |
| Compliant with engine emissions regulations                         | Stage V             | Stage V             | Stage V             | Stage V             |
| ECOBlue™ HI-eSCR 2 system (Selective Catalytic Reduction)           | ●                   | ●                   | ●                   | ●                   |
| Fuel system - High pressure Common Rail                             | ●                   | ●                   | ●                   | ●                   |
| Capacity (cm³)  | 8700                | 8700                | 8700                | 8700                |
| Bore and Stroke (mm)  | 117x135             | 117x135             | 117x135             | 117x135             |
| Approved biodiesel blend**  | B7                  | B7                  | B7                  | B7                  |
| Max. EPM horsepower - ISO TR14396 - ECE R120 [kW/hp(CV)]            | 258/351             | 281/381             | 301/409             | 320/435             |
| Max. horsepower - ISO TR14396 - ECE R120 [kW/hp(CV)]                | 232/315             | 255/347             | 275/374             | 307/417             |
| Rated EPM horsepower - ISO TR14396 - ECE R120 [kW/hp(CV)]           | 232/315             | 255/347             | 276/375             | 305/415             |
| Rated horsepower - ISO TR14396 - ECE R120 [kW/hp(CV)]               | 206/280             | 229/311             | 250/340             | 279/380             |
| Rated engine speed (rpm)  | 2000                | 2000                | 2000                | 2000                |
| Max. torque - ISO TR14396 - @ 1300 - 1400rpm with EPM (Nm)          | 1558                | 1708                | 1800                | 1850                |
| Torque rise Standard / EPM (%)                                      | 40 / 41             | 40 / 40             | 40 / 37             | 39 / 27             |
| Viscous coupled cooling fan   | ●                   | ●                   | ●                   | ●                   |
| Earth friendly engine oil filter                                    | ●                   | ●                   | ●                   | ●                   |
| Exhaust brake   | ○                   | ○                   | ○                   | ○                   |
| Diesel capacity Auto Command™ (Litres)                              | 609                 | 609                 | 609                 | 609                 |
| Diesel capacity Ultra Command™ (Litres)                             | 647                 | 647                 | 647                 | -                   |
| Diesel capacity SmartTrax™ (Litres)                                 | -                   | -                   | 670                 | 670                 |
| AdBlue tank capacity (Litres)                                       | 99                  | 99                  | 99                  | 99                  |
| Service interval (hours)  | 600                 | 600                 | 600                 | 600                 |
| <b>Ultra Command™ full powershift transmission</b>                  |                     |                     |                     |                     |
| IntelliShift™ system  | ●                   | ●                   | ●                   | -                   |
| Ground Speed Management system (GSM)                                | ●                   | ●                   | ●                   | -                   |
| <b>18x4 Ultra Command™ full powershift (40kph)</b>                  |                     |                     |                     |                     |
| Min. Speed (kph)  | 3.34                | 3.34                | 3.34                | -                   |
| <b>19x4 Ultra Command™ full powershift (40kph ECO or 50kph)</b>     |                     |                     |                     |                     |
| Min. Speed (kph)  | 3.34                | 3.34                | 3.34                | -                   |
| <b>Auto Command™ Continuously Variable Transmission</b>             |                     |                     |                     |                     |
| Active StopStart function   | ●                   | ●                   | ●                   | ●                   |
| Force base propulsion control                                       | ●                   | ●                   | ●                   | ●                   |
| <b>Auto Command™ Continuously Variable Transmission (40kph ECO)</b> |                     |                     |                     |                     |
| Min. speed / Max. speed @ 1400rpm (kph)                             | 0.03 / 40           | 0.03 / 40           | 0.03 / 40           | 0.03 / 40           |
| <b>Auto Command™ Continuously Variable Transmission (50kph)</b>     |                     |                     |                     |                     |
| Min. speed / Max. speed @ 1725rpm (kph)                             | 0.03 / 50           | 0.03 / 50           | 0.03 / 50           | 0.03 / 50           |
| <b>Electrical</b>   |                     |                     |                     |                     |
| 12 volt alternator (Amps)   | 240                 | 240                 | 240                 | 240                 |
| Battery capacity (CCA)  | 1900                | 1900                | 1900                | 1900                |
| <b>Axles</b>  |                     |                     |                     |                     |
| 4WD front axle  | ●                   | ●                   | ●                   | ●                   |
| Terraglide™ front axle suspension                                   | ○                   | ○                   | ○                   | ○                   |
| Steering angle Standard / Terraglide™ front axle (°)                | 55 / 55             | 55 / 55             | 55 / 55             | 55 / 55             |
| Turning radius with Standard / Terraglide™ front axle (mm)          | 4970 / 4970         | 4970 / 4970         | 4970 / 4970         | 4970 / 4970         |
| CustomSteer™ system (Adjustable steering ratio)                     | ○                   | ○                   | ○                   | ○                   |
| Terralock™ functions (Auto Diff / Auto 4WD)                         | ●                   | ●                   | ●                   | ●                   |
| Dynamic front fenders   | ○                   | ○                   | ○                   | ○                   |
| Bar rear axle   | ●                   | ●                   | ●                   | ●                   |
| SmartTrax™ rear tracks  | -                   | -                   | ○                   | ○                   |
| Heavy-duty bar rear axle  | -                   | -                   | ○                   | ●                   |
| <b>Hydraulics</b>   |                     |                     |                     |                     |
| Closed Centre Load Sensing (CCLS)                                   | ●                   | ●                   | ●                   | ●                   |
| Standard pump (flow available at couplers) (Lpm)                    | 157                 | 157                 | 157                 | 157                 |
| High Flow pump (flow available at couplers) (Lpm)                   | 214                 | 214                 | 214                 | 214                 |
| MegaFlow™ pump (flow available at couplers) (Lpm)                   | 271                 | 271                 | 271                 | 271                 |
| Electronic Draft Control (EDC)                                      | ●                   | ●                   | ●                   | ●                   |
| <b>Remote valves</b>  |                     |                     |                     |                     |
| Type  | Electro hydraulic   | Electro hydraulic   | Electro hydraulic   | Electro hydraulic   |
| Max. no. rear valves  | 6                   | 6                   | 6                   | 6                   |
| Max. no. front/mid-mount valves                                     | 3                   | 3                   | 3                   | 3                   |
| Joystick control  | ○                   | ○                   | ○                   | ○                   |
| Front remotes via a mid mount valve                                 | ●                   | ●                   | ●                   | ●                   |
| Customizable remote configuration                                   | ●                   | ●                   | ●                   | ●                   |
| <b>Linkage</b>  |                     |                     |                     |                     |
| Rear linkage category   | III/IIIN            | III/IIIN            | IVN / III           | IVN / III           |
| Max. lift capacity at ball ends (kg)                                | 8843                | 9705                | 10927               | 10927               |
| Front linkage category  | II                  | II                  | II                  | II                  |
| Front linkage lift capacity (610mm in front of ball ends) (kg)      | 5810                | 5810                | 5810                | 5810                |
| <b>PTO</b>  |                     |                     |                     |                     |
| Auto Soft Start   | ●                   | ●                   | ●                   | ●                   |
| Engine speed at: 540 / 1000rpm (rpm)                                | 1804                | 1804                | 1804                | 1804                |
| Auto PTO management   | ●                   | ●                   | ●                   | ●                   |
| Front PTO (1000rpm)   | ○                   | ○                   | ○                   | ○                   |
| <b>Brakes</b>   |                     |                     |                     |                     |
| Exhaust brake   | ○                   | ○                   | ○                   | ○                   |
| Electronic park brake   | ●                   | ●                   | ●                   | ●                   |
| Hydraulic trailer brakes  | ○                   | ○                   | ○                   | ○                   |
| Pneumatic trailer braking system                                    | ○                   | ○                   | ○                   | ○                   |

| Models   | T8.350 | T8.380 | T8.410        | T8.435        |
|--|--------|--------|---------------|---------------|
| <b>PLM Intelligence™ system</b>  | ●      | ●      | ●             | ●             |
| IntelliView™ 12 colour monitor   | ●      | ●      | ●             | ●             |
| SideWinder™ Ultra armrest  | ●      | ●      | ●             | ●             |
| CommandGrip™ handle  | ●      | ●      | ●             | ●             |
| InfoView™ instrument cluster   | ●      | ●      | ●             | ●             |
| IntelliSteer® guidance ready   | ●      | ●      | ●             | ●             |
| PLM® Accuracy signals (PLM 1, PLM 2, PLM RTK & PLM RTK+)                 | ○      | ○      | ○             | ○             |
| PLM® Cygnus receiver   | ○      | ○      | ○             | ○             |
| Headland Turn Sequence II (HTS II)                                       | ●      | ●      | ●             | ●             |
| IntelliTurn™ with Headland turn sequencing II (HTS II) system            | ○      | ○      | ○             | ○             |
| MyPLM®Connect telematics (1 <sup>st</sup> years subscription free)       | ●      | ●      | ●             | ●             |
| Remote Assistance (1 <sup>st</sup> years subscription free)              | ●      | ●      | ●             | ●             |
| Processing & Connectivity Module (P&CM)                                  | ●      | ●      | ●             | ●             |
| New Holland Remote Assistance  | ●      | ●      | ●             | ●             |
| IntelliView™ Connect remote display                                      | ●      | ●      | ●             | ●             |
| New Holland Breakdown Assist   | ●      | ●      | ●             | ●             |
| ISOBUS II  | ●      | ●      | ●             | ●             |
| ISOBUS III   | ○      | ○      | ○             | ○             |
| <b>Cab</b>   |        |        |               |               |
| Cab with FOPS - OECD code 10 level 1                                     | ●      | ●      | ●             | ●             |
| Cab category level - EN 15695  | 2      | 2      | 2             | 2             |
| High visibility RHS window   | ●      | ●      | ●             | ●             |
| 12 LED lighting pack   | ●      | ●      | ●             | ●             |
| 16 LED lighting pack   | ○      | ○      | ○             | ○             |
| 20 LED 360 degree lighting pack  | ○      | ○      | ○             | ○             |
| Comfort Ride™ cab suspension   | ○      | ○      | ○             | ○             |
| Semi-Active Comfort Ride™ cab suspension                                 | ○      | ○      | ○             | ○             |
| Auto Comfort™ seat with seat belt  | ○      | ○      | ○             | ○             |
| Auto Comfort™ leather seat with seat belt                                | ○      | ○      | ○             | ○             |
| Instructors seat with seat belt  | ○      | ○      | ○             | ○             |
| Luxury Pack (Leather Steering wheel, carpet and rear tinted window)      | ○      | ○      | ○             | ○             |
| Four way adjustment of SideWinder™ Ultra armrest                         | ●      | ●      | ●             | ●             |
| Telescopic steering wheel adjustment                                     | ●      | ●      | ●             | ●             |
| 170° front hood mounted and cab pillar rear facing cameras               | ●      | ●      | ●             | ●             |
| Electronic remotely adjustable mirrors with wide angle lens              | ●      | ●      | ●             | ●             |
| Extendable heated mirrors  | ○      | ○      | ○             | ○             |
| Remote locking and immobilizer   | ○      | ○      | ○             | ○             |
| Multi-Vent Air conditioning  | ●      | ●      | ●             | ●             |
| Automatic climate control  | ●      | ●      | ●             | ●             |
| Air recirculation filter   | ●      | ●      | ●             | ●             |
| Large portable coolbox   | ○      | ○      | ○             | ○             |
| 10 in cab storage spaces   | ●      | ●      | ●             | ●             |
| MP3 Radio  | ○      | ○      | ○             | ○             |
| MP3 Bluetooth Radio (hands free phone calls)                             | ○      | ○      | ○             | ○             |
| 1 USB power port   | ●      | ●      | ●             | ●             |
| 5 USB power ports  | ○      | ○      | ○             | ○             |
| Fender mounted external controls   | ●      | ●      | ●             | ●             |
| Optimum cab noise level - 77/311 EEC [dB(A)]                             | 67     | 67     | 67            | 67            |
| Factory fit rotating beacons (1 / 2)                                     | ○      | ○      | ○             | ○             |
| <b>Weights</b>   |        |        |               |               |
| Minimum unballasted weights: Std. front axle / including SmartTrax™ (kg) | 10840  | 10840  | 10915 / 16300 | 12514 / 16300 |
| Terraglide™ suspended front axle / including SmartTrax™ (kg)             | 11360  | 11360  | 11440 / 16500 | 13039 / 16500 |
| Max. permissible weight at 50kph*** (Wheeled T8) (kg)                    | 17500  | 17500  | 18000         | 18000         |
| Max. permissible weight at 40kph (T8 SmartTrax)                          | -      | -      | 24500         | 24500         |

● Standard ○ Optional - Not available \* Developed by FPT Industrial

\*\* Biodiesel blend must fully comply with the latest fuel specification EN14214:2009 and operation is in accordance with operator manual guidelines \*\*\* European Highway restrictions



## Dimensions

| With rear tyre / track size****                                |  | 620/70R42   | 710/70R42   | 900/60R42***** | 45.7cm SmartTrax | 61cm SmartTrax | 76.2cm SmartTrax |
|--|--|-------------|-------------|----------------|------------------|----------------|------------------|
| <b>A</b> Overall length inc. weight pack and rear linkage (mm) |  | 6247        | 6247        | 6477           | 6606             | 6606           | 6606             |
| <b>B</b> Min. width (mm)                                       |  | 2534        | 2534        | 2534           | 2787             | 2787           | 2997             |
| <b>C</b> Height at centre of rear axle to top of cab (mm)      |  | 2475        | 2475        | 2475           | 2472             | 2472           | 2472             |
| <b>D</b> Overall height (mm)                                   |  | 3338        | 3407        | 3435           | 3450             | 3450           | 3450             |
| <b>E</b> Wheelbase Ultra Command™ / Auto Command™ (mm)         |  | 3450 / 3500 | 3450 / 3500 | 3550           | 3550 / 3550      | 3550 / 3550    | 3550 / 3550      |
| <b>F</b> Track width (min. / max.) (mm)                        |  | 1727 / 2235 | 1727 / 2235 | 1727 / 2237    | 1930 / 3860      | 1930 / 3860    | 2235 / 3860      |
| <b>G</b> Ground clearance (depends on hitch or tow hook) (mm)  |  | 378         | 364         | 409            | 441              | 441            | 441              |

\*\*\*\* Rear tyres other than those mentioned are available: 650/85R38, 710/70R38, 800/70R38, 710/75R42, 900/60R38

\*\*\*\*\* Ultra Command model only when fitted with Heavy-duty rear axle

# New Holland Top Service: customer support and customer information.



## Top Availability

If you need information, or have an out of hours question, ring our toll-free number\*. All day, every day, we are just a call away.



## Top Speed

Express parts delivery: when you need it, where you need it!



## Top Priority

Fast-track solution during the season: because your harvest can't wait!



## Top Satisfaction

We drive and track the solution you need, keeping you informed: until you are 100% satisfied!



**For more details, ask your New Holland dealer!**

\* Calls to the Top Service team are free from landlines in the United Kingdom and Republic of Ireland. UK-based mobile calls are also free, but Republic of Ireland mobile users should call 01 2421881 and this will be charged at your standard network rate.

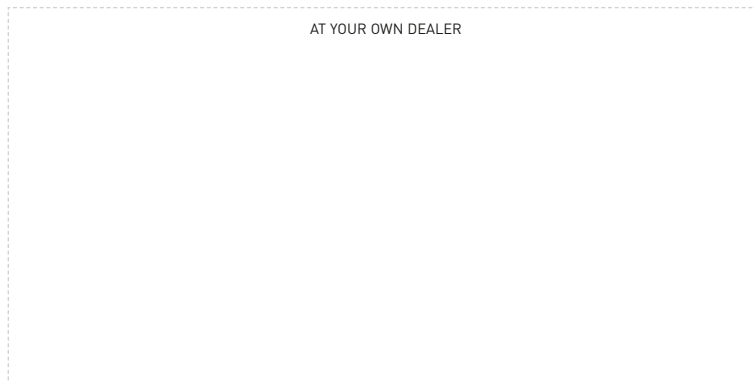

[www.newholland.com/uk](http://www.newholland.com/uk) - [www.newholland.com/ie](http://www.newholland.com/ie)

